

# Kartell



Bloom Ferruccio Laviani

# Technical sheet



9250

## Transparent

B4/crystal



RN/pink-black



## Mat

03/white



09/black





## Material

Transparent or batch-dyed polycarbonate

A lamp as precious as Murano glass, as irreverent as a rock opera - Bloom literally blooms in a scintillating and lavish cascade of crystal.

Bloom is composed of a tubular polycarbonate framework entirely overlaid with a structure of tiny polycarbonate double corolla flowers. The result is a lamp produced industrially but with all the forms and complexities of a unique handcrafted piece. A series of tiny lights located within the skeletal structure beams light shafts through the petals to refract on the faceted surfaces of the petals and multiply a thousand reflections.

It comes in the refined tones of crystal, white matte and in a provocation of pink and black. With its original bamboo form, Bloom is a new way of interpreting a traditional lamp with that added special touch. A work of art that can furnish and fill a room all by itself, creating that sparkling atmosphere of splendour.

	insulation class	directly fitted	degree of protection	tension volt	attachment max power	weight kg.
 <p>9250</p>			IP20 classe II	220-240	E27 max3x70 Halo	8,000
9250	diameter Ø 53	diffusor height 70	cable length 80±240			
packaging	quantity	weight kg.	volume m3			
9250	1	9.500	0,48			

# Layout Podium 1

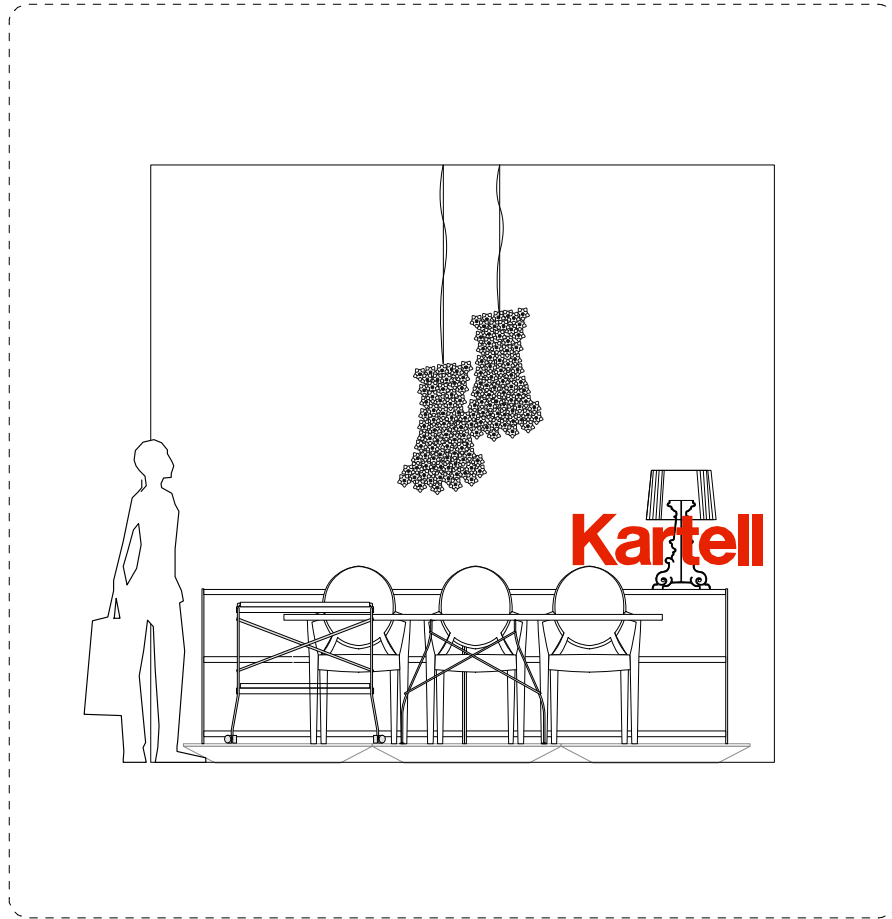

Front shop window

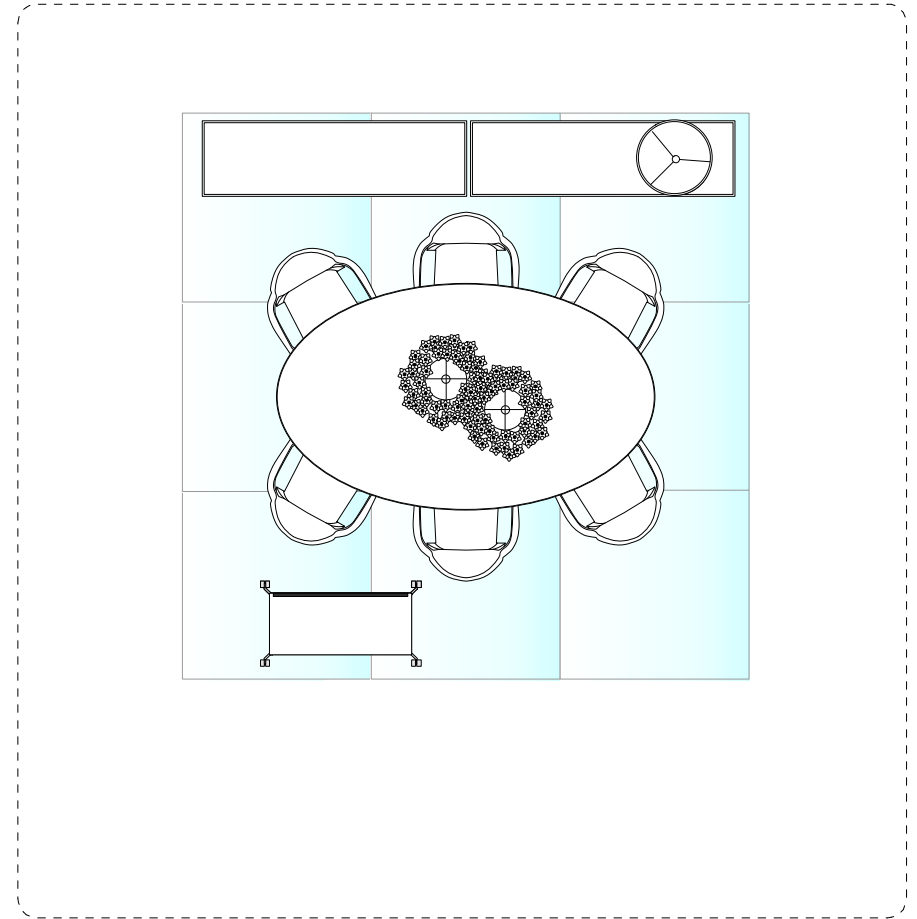

# Layout Podium 2

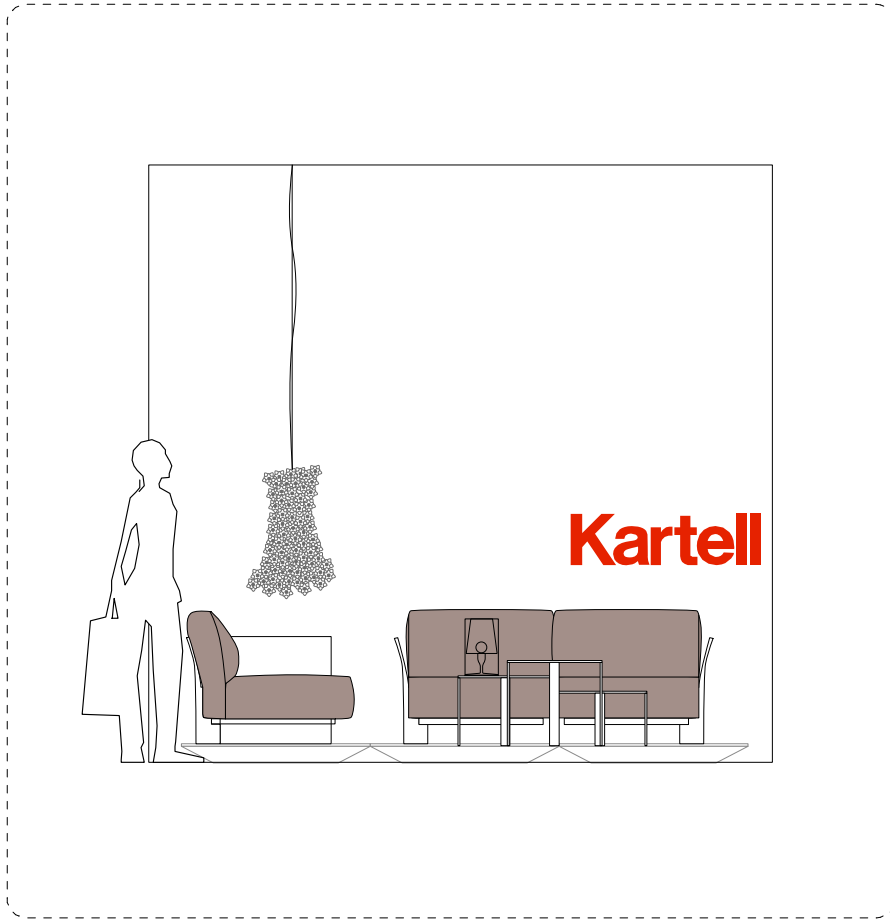

Front shop window

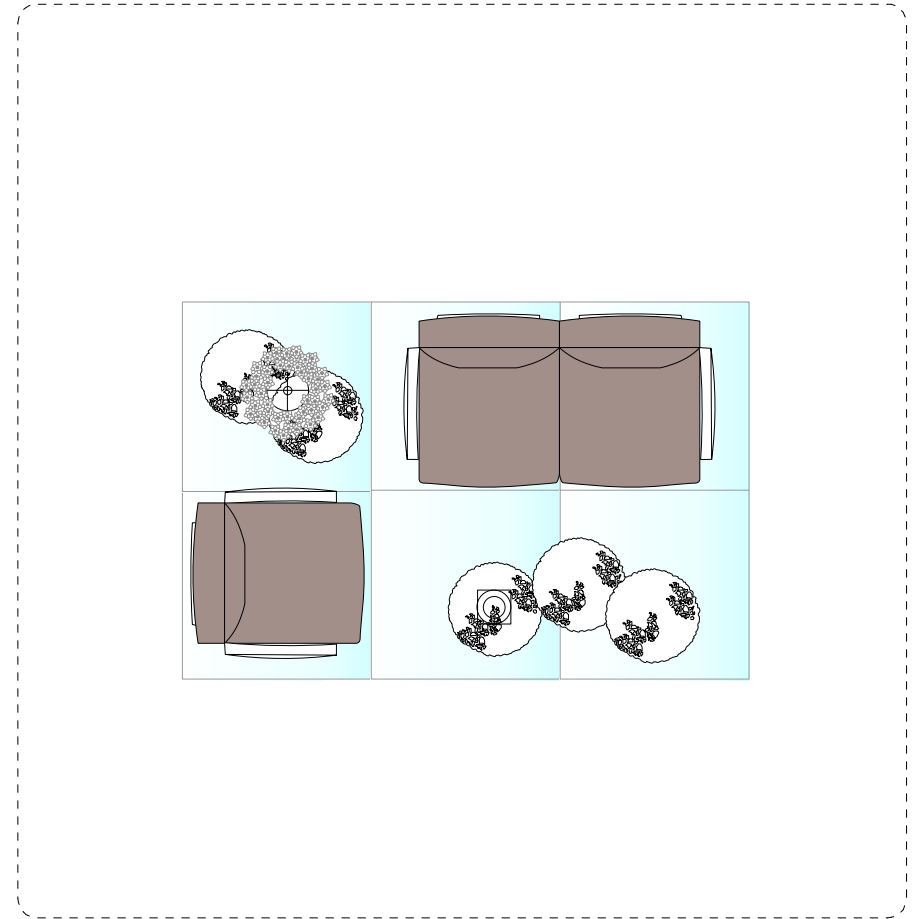

# Layout Podium 3

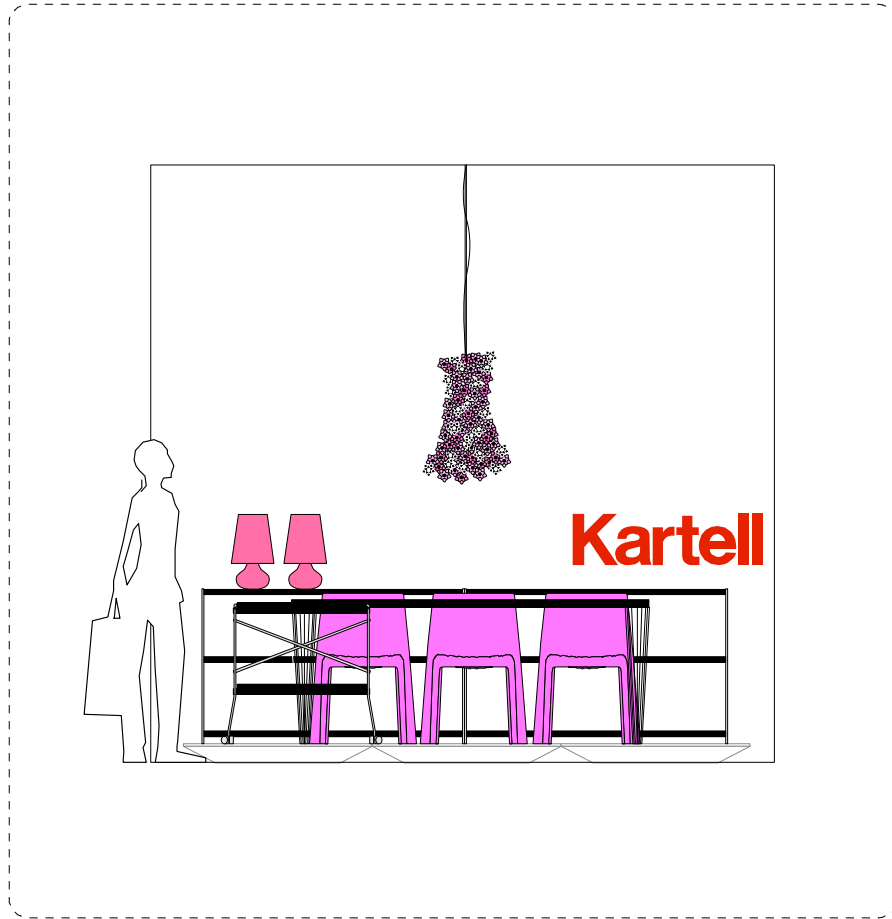

Front shop window

